

veterinary technology for life

Eickemeyer®

www.eickemeyer.com

Telephone +49 7461 96 580 0

Spring Offers *2025*



Valid 20 / 03 / 2025 – 30 / 06 / 2025

LIFEVET PT PULSE OXIMETER WITH TEMPERATURE MEASUREMENT

The portable LifeVet PT can measure and display the functional oxygen saturation of arterial haemoglobin (S_pO_2), pulse rate and body temperature in real time in dogs, cats, and horses. All important parameter information can be easily read on the large LCD display.

- ▶ Small, handy and sturdy
- ▶ Immediately ready for use – no calibration necessary
- ▶ Display of oxygen saturation from 35 to 100 %
- ▶ Display of the pulse rate from 25 to 400 beats per minute (bpm)
- ▶ Display of body temperature from 18 to 45 °C
- ▶ Alarm limits (optical & acoustic) individually adjustable
- ▶ 2.8" TFT LCD colour display with battery level indicator
- ▶ Can be connected to a computer via USB
- ▶ Test results can be stored for up to 360 hours
- ▶ Dimensions (in cm): H 14.2 x W 7.8 x D 2.8
- ▶ Weight: 250 g (device only)
- ▶ Incl. S_pO_2 sensor with two sensor clips (large & small), temperature probe, universal charger, USB cable, Li-Ion battery, protective silicone case and holder for tabletop use

321860



LIFEVET CP CAPNOGRAPH AND PULSE OXIMETER

The LifeVet CP handheld Capnograph and Pulse Oximeter measures and displays the expiratory CO_2 concentration as well as the respiratory rate, pulse rate and oxygen saturation in dogs, cats and horses. This compact and portable device is very easy to use with its touchscreen display and intuitive interface.

- ▶ High resolution 4.3" touchscreen display
- ▶ Side-stream capnography
- ▶ Et CO_2 concentration: 0–150 mmHg
- ▶ Respiratory rate displayed in rpm
- ▶ S_pO_2 range: 1–100 %
- ▶ Pulse rate: 25–250 bpm
- ▶ Audible and visual alarms with adjustable volume
- ▶ Long-life lithium battery: up to 18 h operating time
- ▶ Dimensions (in cm): W 7.7 x H 14.1 x D 3.6
- ▶ Weight: 420 g
- ▶ Includes: CO_2 tube, CO_2 filter, net adapter, USB cable, clip sensor

321880



LIFEVET 10M MULTIPARAMETER MONITOR

**ORDER
ONLINE**

www.eickemeyer.com

The LifeVet 10M is a fast, accurate and comfortable patient monitor that is characterised by its high ease of use and reliable technology. Its innovative technology is the ideal basis for obtaining detailed data and enabling first-class visualisations. Thanks to the large display, the vital functions can also be easily read from a distance. It is operated conveniently via touchscreen. Hot keys also provide quick access to the most important functions. The low power consumption and powerful battery make this monitor an extremely efficient solution.

- ▶ Multi-parameter display of respiratory rate, pulse rate, oxygen saturation, blood pressure (NIBP), ECG and temperature
- ▶ High-resolution 10.4" LED touchscreen with up to 7 curves
- ▶ Freely selectable alarm limits
- ▶ Mains and battery operation up to 4 hours
- ▶ Dimensions (in cm): W 32 x H 22 x D 16
- ▶ Weight: approx 3.5 kg
- ▶ Incl. Li-Ion battery, NIBP cable with cuff, ECG cable with clamps, SpO₂ sensor with clips and temperature probe

321915

**STOCK
SELLOUT**
As long as
stock lasts



LIFEVET 10C MULTIPARAMETER MONITORS

The LifeVet 10C monitors are modern, powerful patient monitors that are characterised by their high level of user-friendliness, reliable technology and extensive data storage. Thanks to the large display, the vital functions can also be read easily from a distance. It is operated conveniently via touchscreen. Hot keys also provide quick access to the most important functions.

- ▶ Multi-parameter display of respiratory rate, pulse rate, oxygen saturation, blood pressure (NIBP), ECG, temperature and capnography (EtCO₂) in sidestream mode
- ▶ High-resolution 10" LED touchscreen with up to 8 curves
- ▶ Freely selectable alarm limits and 360° visible alarm display
- ▶ Mains and battery operation up to 4 hours
- ▶ Dimensions (in cm): W 27 x H 22 x D 17
- ▶ Weight: ≤ 4.0 kg
- ▶ Incl. Li-Ion battery, NIBP cable with cuff, ECG cable with clamps, SpO₂ sensor with clips, temperature probe, CO₂ adapter, CO₂ cable and water trap



321921

EICKEMEYER® NARKOVET II ANAESTHETIC UNIT

Your Veterinary Anaesthesia Solution

The EICKEMEYER® NarkoVet II is a state-of-the-art anaesthesia machine specifically designed for veterinary medicine. This compact and visually appealing device features a clear and organized structure of all components, ensuring ease of use. With the included mounting plate, an optional O₂ concentrator can be conveniently installed directly on the stable, mobile stand, optimising space and functionality in your practice.

- ▶ O₂ Flowmeter (0.1 – 4.0 l/min)
- ▶ Oxygen bypass (O₂ flush)
- ▶ Isoflurane vaporiser, key filled
- ▶ CO₂ absorber lime container with quick-change system
- ▶ Infinitely adjustable pressure relief valve
- ▶ Pressure gauge to display the system pressure
- ▶ External fresh gas outlet for open system
- ▶ Easy change of circuits using a toggle switch
- ▶ Hanger for hygienic storage of patient tubes
- ▶ Holder for anaesthetic gas filter
- ▶ Incl. O₂ concentrator tray, ventilator tray (NarkoVet SAV II), patient tubes (coaxial / open), rebreathing bags (0.5 l, 1 l & 2 l) and anaesthetic gas filter with scavenging hose

213130

OxyVet III Oxygen Concentrator (5 l)

An oxygen concentrator draws in room air, separates the oxygen from other gases in the environment and delivers the oxygen at high concentrations.

- ▶ Flowrate: 0.5 to 5 l/min
- ▶ Oxygen concentration: 93 % ± 3 %
- ▶ Sound level: 40 dbA (50 Hz)
- ▶ Electrical requirements: 230 V / 50 Hz
- ▶ Power consumption: approx. 290 watt at 2 l/min and approx. 312 watt at 5 l/min
- ▶ Dimensions (in cm): L 34 x W 30.4 x H 62
- ▶ Weight: 16.3 kg
- ▶ 3 Year Warranty

213175

NarkoVet Anaesthetic Starter Kit

Complete Set, consisting of:

- ▶ Safety fill neck for isoflurane
- ▶ 3 soda lime, 4,5 kg, with color change
- ▶ Breathing bag, 3 l
- ▶ 6 plastic breathing masks (size 1 – 6)
- ▶ Complete set of EickTube tracheal tubes, 23 pcs. (2,0–10,0 mm)
- ▶ Laryngoscope ECONOMY

213131



213175



213130

Maximum Safety for Your Patients with the EICKEMEYER® NarkoVet PRO

The main cause of serious anaesthesia incidents in veterinary practices is the patient's unnoticed apnoea. Routinely controlled ventilation helps to drastically minimise this risk, ensuring optimal safety for your patients. The EICKEMEYER® NarkoVet PRO features an integrated ventilator powered by an electronic turbine, eliminating the need for drive gas from an external compressor. To protect your patients and staff, the system performs an automatic leak test at start-up.

Anaesthesia Machine

- ▶ O₂ Flowmeter (0.1 – 4.0 l/min)
- ▶ Oxygen bypass (O₂ flush)
- ▶ Isoflurane vaporiser, key filled
- ▶ CO₂ absorber lime container with quick-change system
- ▶ Infinitely adjustable pressure relief valve
- ▶ Pressure gauge to display the system pressure
- ▶ External fresh gas outlet for open system
- ▶ Easy change of circuits using a toggle switch
- ▶ Holder for anaesthetic gas filter

Ventilator

- ▶ Electronically controlled, no compressed air source required
- ▶ All ventilation parameters on a large, 8" touchscreen
- ▶ Patient safety through acoustic and visual alarms
- ▶ Automatic calculation of ventilation volume based on weight
- ▶ Patients from 0.5 – 150 kg can be ventilated
- ▶ Tidal volume from 5 ml, for precise ventilation of the smallest patients
- ▶ Supported ventilation modes:
 - Volume-controlled ventilation (VCV)
 - Volume-supported (VS)
 - Pressure-controlled ventilation (PCV)
 - Synchronised intermittent mandatory ventilation – pressure-controlled (SIMV-PC)
 - Continuous positive airway pressure / pressure-supported ventilation (CPAP/PSV)
 - Pressure-regulated volume-controlled (PRVC)
 - Synchronised intermittent mandatory ventilation – Pressure-regulated volume-controlled (SIMV-PRVC)
 - Pressure-supported ventilation protection (PSVPro)
- ▶ Ventilation rate: 4 – 100 bpm
- ▶ Tidal volume: 5 – 1,500 ml
- ▶ Maximum ventilation pressure: 3 – 50 cmH₂O
- ▶ Trigger pressure -20.0 to -1 cmH₂O
- ▶ Mains and battery operation, battery life min. 2 hours

Further Specs

- ▶ Incl. O₂ concentrator tray and patient tube with rebreathing bag (1 l)
- ▶ Dimensions (in cm): L 64 x W 67 x H 140
- ▶ Weight: approx. 43 kg
- ▶ Sevoflurane option available upon request

213040

EICKEMEYER® NarkoVet PRO O₂

- ▶ Like NarkoVet® PRO but with a second flow meter for air

213041



213041

INFUSOVET SP SYRINGE DRIVER / PUMP

The EICKEMEYER® InfusoVet SP is a highly accurate and reliable syringe pump. The clearly arranged, colour coded buttons make it particularly easy to use.

- ▶ 2.5" backlit LCD display
- ▶ Compatible with standard 5, 10, 20, 30, 50 and 60 ml syringes
- ▶ Safety when injecting: precise control of flow rate and injection volume
- ▶ High patient safety through acoustic alarms
- ▶ Quick start function
- ▶ With clamp for IV pole

Technical specifications

- ▶ Mains and battery operation, battery life up to 6 hours
- ▶ Splash proof (IP34)
- ▶ Dimensions (in cm): L 33 x D 12.6 x H 11
- ▶ Weight: approx 1.8 kg

402095



STOCK
SELLOUT
As long as
stock lasts

EICKEMEYER® I.V. FLUID WARMER

- ▶ For warming up all intravenously administered liquids
- ▶ LED display with temperature display
- ▶ Temperature control from 35 to 42 °C in 0.1 °C steps
- ▶ Warm-up time: less than 2 min
- ▶ Dimensions (in cm): L 18 x W 7 x D 3.5
- ▶ Weight: 200 g (without mounting clamp)

402092



I.V. GIVING SET

- ▶ Pressure / gravity infusion
- ▶ Individually packaged sterile sets
- ▶ DEHP & Latex free
- ▶ Compatible with infusion pump InfusoVet, InfusoVet Easy II, InfusoVet Connect and InfusoVet IP
- ▶ **Please note:** If you use a pump that is not from EICKEMEYER®, your pump for this infusion set must be calibrated accordingly.
- ▶ Pack of 100 pieces
- ▶ Extension 050166 is compatible with this giving set.

402071



INFUSOVET CONNECT INFUSION PUMP

ORDER
ONLINE

www.eickemeyer.com

- ▶ 4.3" color touchscreen for easy operation
- ▶ Adjustable audible and visual alarms
- ▶ Suitable for bloods
- ▶ Flow rate: 0.1 – 2,000 ml/h
- ▶ Bolus rate: 0.1 – 2,000 ml/h (automatic and manual)
- ▶ Occlusion level: 5 levels selectable (50 – 900 mmHg)
- ▶ Mains and battery powered (up to 10 h)
- ▶ With clamp for IV pole and cage holder
- ▶ For EICKEMEYER® infusion sets (item no. 402071)
- ▶ Dimensions (in cm): W 13.8 x H 13.2 x D 9
- ▶ Weight: 1.5 kg

402090



INFUSOVET IP II INFUSION PUMP

The advanced InfusoVet IP II Infusion Pump combines the latest technology with a user-friendly design to make the administration of fluids and medications more precise and efficient.

- ▶ User-friendly thanks to simple programming
- ▶ Patient safety thanks to acoustic and visual alarms
- ▶ Suitable for blood transfusions
- ▶ Stand prevents the infusion line from being disconnected
- ▶ Incl. clamp for drip stand
- ▶ Side power connection does not protrude into the cage
- ▶ Compatible with most pump specific infusion lines. May require calibration.

Technical specifications

- ▶ Flow rate: 0.1 – 2,000 ml/h
- ▶ Volume limit: 0.1 – 9,999 ml
- ▶ Bolus rate: 0.1 – 2,000 ml/h (auto + manual)
- ▶ Occlusion level: 5 levels selectable (150 – 1,125 mmHg)
- ▶ Mains and battery operation for up to 4.5 hours
- ▶ Splash protection in accordance with IP44
- ▶ Dimensions (in cm): W 35 x H 20 x D 12
- ▶ Weight: < 1.2 kg

402087



OPERATING TABLE ELECTRIC OR HYDRAULIC

- ▶ Shapely stainless steel base with four adjustable rubber feet, provides stability on uneven floors
- ▶ Self-contained, maintenance-free lift column
- ▶ Height adjustable from 72–112 cm
- ▶ Unidirectional tilt mechanism up to 90°
- ▶ Stainless steel top with rounded, anti-drip edges and drain hole
- ▶ Tabletop available in two different sizes (50 x 130 cm or 60 x 130 cm)

Electric

- ▶ 50 x 130 cm

601550

- ▶ 60 x 130 cm

601560

Hydraulic

- ▶ 50 x 130 cm

601950

- ▶ 60 x 130 cm

601960

Table Tie Down Cleats

- ▶ Stainless steel construction
- ▶ Mounted under the table

602005

Standard Rail System

Enables quick, safe and variable fixing of the patients on the table.

Consisting of:

- ▶ 2x Standard Rails, side
- ▶ 2x Standard Rails, end
- ▶ 4x Tie Down Cleats, quick release
- ▶ 10x Tie Down Ropes, L 1 m

605050



HYDRAULIC TABLE

The hydraulic mechanism helps protect your back. The heavy duty frame ensures stability throughout its range. All four castors can be locked simultaneously with the foot switch.

Technical specifications

- ▶ Minimum height: 49.5 cm
- ▶ Maximum height: 98 cm
- ▶ Maximum load: 100 kg
- ▶ Four lockable castors
- ▶ Tabletop dimensions (in cm): L 122 x W 60
- ▶ Includes: 6 tie-down cleats

600200



LOW LIFT SCISSOR TABLE II









**ORDER
ONLINE**

www.eickemeyer.com

The EICKEMEYER® Low Lift Scissor Table II is perfect for lifting and transporting larger patients without unnecessary handling and movement. The basic stationary table is available in eight different colours and the additional options available make this table a real all-rounder for your practice.

- ▶ Ideal for examination, prep, dental treatment and procedures
- ▶ Minimum height of 28 cm allows large dogs to walk onto the table
- ▶ Maximum height of 105 cm allows you to examine smaller patients without having to hunch and lean forward
- ▶ All parts made from high quality German stainless steel
- ▶ Smooth, polished tabletop (60 x 130 cm) with rounded corners, anti-drip edges and a drain hole
- ▶ Silent electric operation via foot pedal
- ▶ Includes power supply and tie down cleats

604200

Illustration	RAL No.	Colour
		Stainless Steel
	3000	Flame Red
	6018	Lime Green
	5022	Night Blue
	2001	Red Orange
	6005	Moss Green
	4010	Pink
	9010	Pure White

Additional Options

In addition to the stationary table, you can choose one or more of the following table options:

Battery Kit

- ▶ Includes Battery and Charger

Mobil Kit

- ▶ Includes Wheels, Battery and Charger

Electric Tilt Option

- ▶ For tabletops

Integrated Scale Option

- ▶ Weighing range 0–120 kg

Curved Dental Tray

- ▶ With removable tray with grid
- ▶ Tray size (in cm):
W 50 x D 35

604303



**Configure
ONLINE**



SCORE® AMAZONE / JUMPER STOOLS

The ever so popular SCORE® treatment stools now come in fresh colours – real eye-catchers for your practice!

- ▶ Comfortable, cushioned seat
- ▶ Easily washable synthetic leather
- ▶ Smooth running double castors
- ▶ Aluminium base diameter: 54 cm

SCORE® JUMPER / AMAZONE Balance

The uniquely adjustable Balance mechanism from SCORE® ensures that the saddle moves subtly along with your movements. These 'micro' movements of your pelvis ensure that muscle groups and intervertebral discs are not constantly under severe static strain. This prevents pain, helps you maintain your working posture longer and exercises your core muscles. The degree of movement can be set by your own preference and adjusted by rotating the ring.



AMAZONE (narrow)



JUMPER (wide)



Balance (flexible)

Configure
ONLINE



Illustration	Colour
	Black
	Anthracite
	Capri Blue
	Forest Green
	Burgundy
	Orange
	Pink
	Ochre Yellow



SCORE® MEDICAL TREATMENT AND OPERATING CHAIR

**ORDER
ONLINE**

www.eickemeyer.com

- ▶ Comfortable, padded seat with Ø 40 cm
- ▶ Easily washable synthetic leather cover
- ▶ Height adjustable by gas spring from approx. 55 – 74 cm
- ▶ Smooth PU double castors
- ▶ Optimal freedom of movement
- ▶ Aluminum base with Ø 54 cm

With lumbar support









- ▶ Compact, functional lumbar support
- ▶ Height and inclination easily adjustable
- ▶ Colour: black

610190

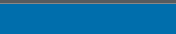
With lumbar support and foot operation

- ▶ Foot operation allows easy adjusting of seat height during operations (operator remains sterile)
- ▶ Colour: black

610195

Illustration	Colour
	Black
	Anthracite
	Capri Blue
	Forest Green
	Burgundy
	Orange
	Pink
	Ochre Yellow

**Configure
ONLINE**



610195

ZWEEZI SADDLE STOOL

- ▶ Padded synthetic leather seat
- ▶ Adjustable height: 58 – 85 cm
- ▶ Seat width: 40 cm
- ▶ Gas lift mechanism
- ▶ Base diameter: 54 cm
- ▶ 5 star base with swivable castors
- ▶ Colour: evergreen

610176



ZWOOZI ROUND STOOL

- ▶ Padded synthetic leather seat
- ▶ Adjustable height: 64 – 85 cm
- ▶ Seat width: 35 cm
- ▶ Gas lift mechanism
- ▶ Base diameter: 54 cm
- ▶ 5 star base with swivel castors
- ▶ Colour: evergreen

610177



CT, MRI AND ULTRASOUND POSITIONER

- ▶ Facilitates positioning of patients to allow abdominal ultrasonography
- ▶ Perfect positioning helps keep the patient calm and comfortable
- ▶ Robust, easy to clean and disinfect

Size 1

- ▶ Suitable for cats/small dogs
- ▶ Dimensions (in cm):
W 25 x H 10 x L 80

303991

Size 3

- ▶ Suitable for large-sized dogs
- ▶ Dimensions (in cm):
W 50 x H 20 x L 130

303993

Size 2

- ▶ Suitable for medium-sized dogs
- ▶ Dimensions (in cm):
W 35 x H 14 x L 100

303992



303992

ULTRASOUND TABLE ATTACHMENT WITH CUTOUT

The redesigned EICKEMEYER® Ultrasound Table is the perfect solution for cardiac ultrasound examinations.

- ▶ Redesigned ergonomic cut out for cardiac ultrasound examinations
- ▶ 5 foldable feet for easy storage
- ▶ Ergonomically designed recess
- ▶ Provides ample elbow room for the examiner
- ▶ Compatible with Examination Tables
(Width: 45 cm / Length: 100 cm)
- ▶ Dimensions (in cm): W 60 x H 19 x L 14

303976

Ultrasound Table Mat with Cutout

- ▶ For Ultrasound Table (item no. 303976)
- ▶ Velcro straps for a secure fit

30397602

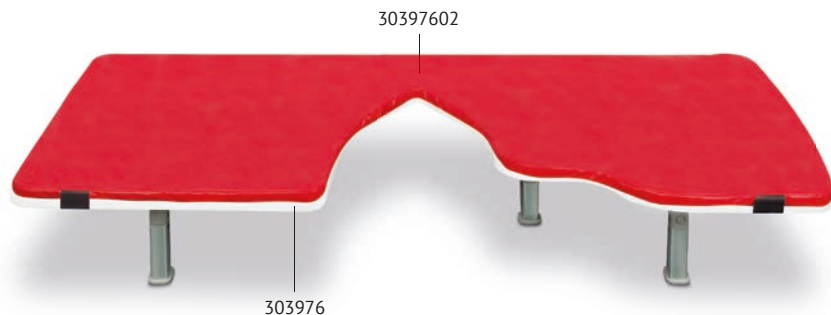

EICKEMEYER® PAWSITIONER

**ORDER
ONLINE**

www.eickemeyer.com

The Pawsitioner is designed to secure patients for surgery and hands-free diagnostic imaging. It eliminates the need for tie-downs and makes it easy to clip and scrub patients in the prep room then transport them to surgery without having to re-position. The Pawsitioner is also ideal for hands-free radiographic positioning, including V-D, left or right lateral, V-D pelvis for OFA evaluation, rostral-caudal skull views and much more without re-positioning the patient for each radiograph. The cradle may also be used to hold patients for laparoscopy, CT, MRI, myelography and ultrasonography.

Complete Set

- ▶ Consisting of 5 sizes and wall mount for space-saving storage

605920



QR code for the application video of the Pawsitioner

ANIMAL STRETCHER TROLLEY

We get a lot of positive feedback regarding this Animal Stretcher Trolley. It will quickly become essential for transporting patients within your practice, and you will wonder how you ever managed without it.

This mobile trolley has four lockable castors so patients can be transported and secured easily.

- ▶ 4 lockable castors
- ▶ Aluminium frame with a washable nylon cover
- ▶ Maximum load capacity: 60 kg
- ▶ Dimensions (in cm): L 120 x W 52 x H 80

605998



ZLIG – NEW TECHNIQUE FOR CRUCIATE LIGAMENT REPLACEMENT (CRCL)

Zlig – the history

The tear of the anterior cruciate ligament is still one of the most common orthopaedic diseases in dogs. The path of the many surgical methods developed for this vary from intracapsular and extracapsular techniques to modern corrective osteotomies that alter the geometry of the affected knee joint. With the development of new materials in medical technology, it is now possible to replace the cranial cruciate ligament in an anatomically correct manner, instead of changing the forces acting on the joint. After a long period of preparatory work by the French Dr. Jacques-Phillipe Laboureau, a suitable synthetic ligament is now available for the intra-articular cruciate ligament replacement in small animals. Together with the instrumentation developed by EICKEMEYER®, this new technique for cruciate ligament replacement can now be performed.

Zlig – the implant

The Zlig consists of ultra-high-molecular polyethylene with the special feature that the woven structure of the implant is interrupted intra-articularly by “free fibres”. Free parallel fibres reduce fatigue and also encourage the ingrowth of fibroblasts and collagen. Each implant is delivered in a sterile packed sleeve, making it easier to handle the implant before it is inserted into the joint. A selection of sizes with different resistances and fibre lengths are available to fit different patient sizes.

Zlig – the technology

In this technique, an artificial ligament is used as a total replacement for the anterior cruciate ligament using tunnel-tunnel-technique. The ligament is fixed in the tibia and Os femoris using specially developed cannulated interference screws in drill channels. The screws are guided parallel to the ligament using a guiding wire to avoid deviations. The technology does not cause irreversible damage and the results are reproducible thanks to a quick learning curve. Another great advantage of the technique is the fact that patients can put weight on the hind leg immediately after the operation without any risks.

16 Fibres / 10 mm

- ▶ 5–8 kg
- ▶ 2,000 N

191501

24 Fibres / 15 mm

- ▶ 8–12 kg
- ▶ 3,000 N

191502

32 Fibres / 17 mm

- ▶ 12–25 kg
- ▶ 4,000 N

191503

48 Fibres / 19 mm

- ▶ 25–45 kg
- ▶ 6,000 N

191504

48 Fibres / 22 mm

- ▶ 25–45 kg
- ▶ 6,000 N

191505

48 Fibres / 25 mm

- ▶ 25–45 kg
- ▶ 6,000 N

191506

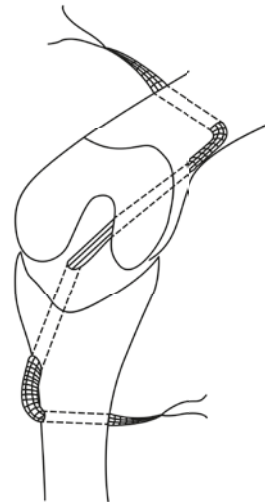

QR code for the application video of the Zlig

ZLIG 2 – NEW TECHNIQUE FOR CRUCIATE LIGAMENT REPLACEMENT (CRCL)

Zlig 2 – the instrumentation

A small and inexpensive set of instruments is required to perform this innovative cruciate ligament surgery method. The threads of the specially developed titanium interference screws are round so they do not cause any damage to the fibres of the Zlig.

197500



EICKLOXX SMALL CONTOUR OSTEOSYNTHESIS SYSTEM

ORDER
ONLINE

www.eickemeyer.com

The EickLoxx Small Contour plate set includes various anatomically preformed osteosynthesis plates for the treatment of fractures of the distal radius and femur, ilium, acetabulum and for arthrodesis of the carpus and tarsus. It complements the cut-to-size plates of the EickLoxx Small osteosynthesis system and is therefore also designed for the treatment of cats and dogs up to 15 kg. The instruments from the EickLoxx Small osteosynthesis system are used in a similar way.

The titanium plates of the EickLoxx Small Contour plate set are available in two plate thicknesses: The 2.2 mm plates (yellow, green and magenta) can be locked polyaxially with the 1.7 mm and 2.3 mm screws and the 3.0 mm plates (light blue) optionally with the 2.7 mm, 3.5 mm and 4.0 mm screws of the EickLoxx series.

Despite contouring, the panels can be bent as required using the cabinet iron and / or the panel bending pliers with rollers and shortened using the cutting pliers.

The sieve tray with the EickLoxx Small Contour plates fits into the container Art. No. 185555 on the two sieve trays of the EickLoxx Small system.

197900

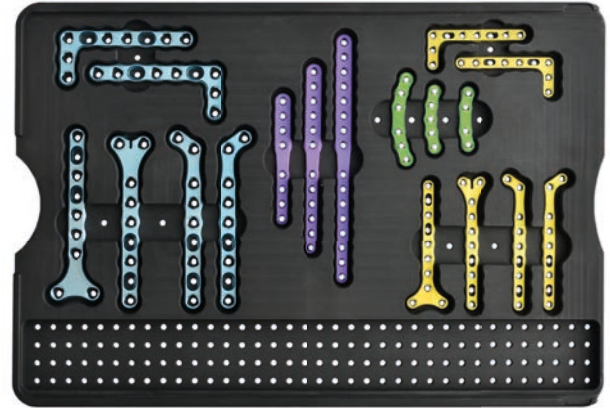

EICKLOXX SMALL OSTEOSYNTHESIS SYSTEM

The EickLoxx Small is a polyaxial locking kit for dogs and cats up to 15 kg.

The system distinguishes itself through the polyaxial placement of the custom-fit screws and combines the advantages of a locking plate system with polyaxial screw placement in $\pm 15^\circ$ longitudinal and transverse pivoting.

Compared to conventional osteosynthesis systems, the use of locking systems (internal fixation) such as the EickLoxx Small facilitates faster healing of fractures and improved implant strength. It is for this reason that the removal of plates and screws is rarely indicated.

The biologically advantageous titanium plates are available in three sizes and can be cut to the desired length and bent in three planes. Specially designed tools are included to perform this. Titanium also reduces artefacts in post-operative imaging.

EickLoxx Small is a modular system. All implants and instruments are made in Germany using only the highest quality materials.

185500

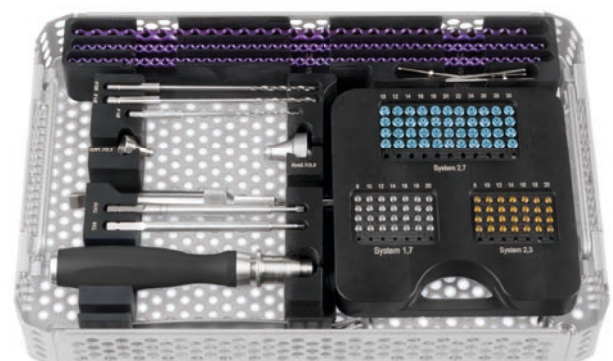
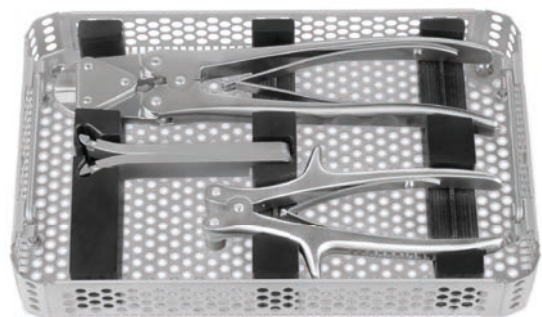

ORTHOVET PRO BATTERY POWERED DRILL SYSTEM

The ideal tool for small animal osteosynthesis

The OrthoVet PRO is a modular, battery driven drill system designed for small animal osteosynthesis. The modular system consists of a handpiece and four attachments, which can be changed intraoperatively in just a few seconds with a keyless quick coupling.

The handpiece, the quick release AO Chuck and the Jacobs Chuck are cannulated. Thus, cannulated screws or drills can also be tracked over long guide wires in stages, without the guide wire having to be shortened. The oscillating saw has a fivefold adjustable, variable fixation of the saw blade and allows the surgeon an optimised view of the surgical field. The AO quick coupling completes the system and makes the OrthoVet PRO a real all-rounder.

The handpiece and attachments can be sterilised / autoclaved. The Li-Ion Battery is not autoclavable and is inserted into the handpiece by means of special holder. Continuous operation is possible in clockwise and counterclockwise motion, as well as in oscillation with the saw attachment.

- ▶ 4 attachments: Jacobs Drill Chuck, Quick Release AO Chuck, Quick Release Chuck for KIRSCHNER wires, Oscillating Saw with Saw Blades
- ▶ Fully Cannulated Handpiece
- ▶ Autoclavable
- ▶ Includes 2 Li-Ion Batteries with Charger and Transport Case

Technical specifications

- ▶ Infinitely variable speed: 0–1,200 rpm
- ▶ Oscillation mode: 0–16,000 ocs/min
- ▶ Battery type: Li-Ion
- ▶ Battery charging time: 180 min
- ▶ Weight (includes Battery): 933 g

195000



PROFIDENT PLUS DENTAL UNIT

**ORDER
ONLINE**
www.eickemeyer.com

The Profident PLUS is the result of many years of experience. It offers a wide range of applications for both, general practitioners and dental specialists. It is characterised by its modern design combined with high mobility. The stand is adjustable in height and all handpieces are arranged within easy reach of the operator. When a handpiece is removed from its holder, the Profident PLUS automatically supplies air and water to it.

Starter Kit

Complete set, consisting of:

- ▶ 1x Bur Kit for Contra Angle
- ▶ 1x Prophy Cups
- ▶ 1x Polishing Paste
- ▶ 1x Cleaning Brush

EXP174004

High Speed Turbine (300,000 rpm)

- ▶ Push button burr change for friction grip burs (FG)
- ▶ Variable burr water cooling facility
- ▶ With LED Illumination

Low Speed Air Motor (20,000 rpm) with Straight Handpiece

- ▶ For long straight shank burs (HP), diamond discs and prophy heads
- ▶ High torque, forward and reverse rotation
- ▶ Optional water cooling facility (item no. 174022)

Built-in Dental Scaler

- ▶ Handpiece with LED Illumination
- ▶ Includes 5 scaling tips

3 in 1 Syringe

- ▶ Precise finger tip control of water, mist or dry air
- ▶ Water connection to connect external dental scaler (e.g. item no. 176870)

Dental Unit Air Compressor

- ▶ Powerful (340 watt)
- ▶ Quiet, 40 dB (A) (as a fan)
- ▶ Low maintenance

Micro Oil Filter

- ▶ Reduces the oil content in the compressed air down to 0.01 %
- ▶ Helps extend the life of handpieces

174001



Scaler with LED lighting



Dental Handpiece
High Speed (FG)



174001

MOBILE DENTAL CART

Turns every table into a dental treatment table!

With the Mobile Dental Cart from EICKEMEYER®, every operating or treatment table becomes an ergonomic dental treatment table.

- ▶ For attachment to operating and treatment tables
- ▶ Ergonomic, curved dental tray with grate
- ▶ Easily removable tray for cleaning
- ▶ Made of stainless steel
- ▶ With 4 lockable smooth running castors
- ▶ Height adjustable from 75 – 100 cm
- ▶ Tray size (in cm): W 50 x D 35

605105



DENTANOMIC DENTAL INSTRUMENTS

Easier, safer & faster dental surgery

DENTANOMIC instruments are premium surgical tools with superb tempered and hardened modular blades making dental extraction in dogs and cats easier, safer and faster.

- ▶ Blades are made from top quality, hardened stainless steel and cut much better than conventional instruments
- ▶ Unique modular design allows easy blade replacement when blades are blunt or damaged
- ▶ Ergonomic handle design promotes safe palm grip, only minimal finger force is required to stabilise the cutting edge
- ▶ Standard handles are perfectly balanced and sized for surgeons with hands up to 7.5 glove size



DENTANOMIC Dental Instruments	
Item no.	Description
175000	Ergonomic Handle, blue
175001	Ergonomic Handle, green
175002	Ergonomic Handle, pink
175008	Ergonomic Handle, orange
175009	Ergonomic Handle, purple
175005	Ergonomic Handle, blue, longer shaft
175006	Ergonomic Handle, green, longer shaft
175007	Ergonomic Handle, pink, longer shaft
175003	Ergonomic Handle, orange, longer shaft
175004	Ergonomic Handle, purple, longer shaft
175100	Elevator Tip, 2 mm
175101	Elevator Tip, 3 mm
175102	Elevator Tip, 4 mm
175103	Elevator Tip, 5 mm
175104	Luxation Tip, 1.5 mm
175105	Luxation Tip, 2 mm
175106	Luxation Tip, 3 mm
175107	Luxation Tip, 4 mm
175108	Luxation Tip, 5 mm
175200	Storage and Sterilisation Rack for 9 blades
175202	Sterilisation Container for 5 handles
175201	Honing Pack, extra-fine

DENTANOMIC PERIOSTEAL ELEVATOR SET

DENTANOMIC dental instruments are an innovation in the field of dental surgery and significantly simplify tooth extraction. With the interchangeable blades, the instruments can be quickly and easily adapted to the respective surgical situation. In addition, once the blade wears out, the entire instrument no longer needs to be thrown away. The blades are extra hardened and have a special, very sharp grind.

- ▶ Set consisting of 4 periosteal elevator blades (2, 4, 6 and 8 mm) and sterilization container

175115

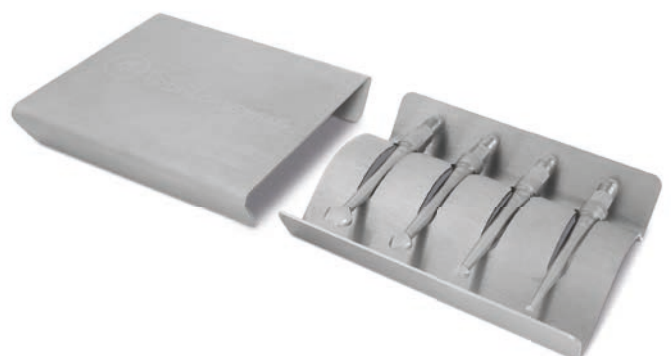

DENTANOMIC Set – Bronze

Complete Set, consisting of 2 handles (purple and gold) + elevator blade set (all sizes) + luxator blade set (all sizes) + sterilisation and storage rack

Up to glove size 7.5

175050

From glove size 8.0

175051

DENTANOMIC Set – Gold

Complete Set, consisting of 5 handles (purple, gold, green, blue and pink) + elevator blade set (all sizes) + luxator blade set (all sizes) + sterilisation and storage rack + honing set + sterilisation container

Up to glove size 7.5

175070

From glove size 8.0

175071

DENTANOMIC Set – Silver

Complete Set, consisting of 3 handles (green, blue and pink) + elevator blade set (all sizes) + luxator blade set (all sizes) + sterilisation and storage rack + honing set

Up to glove size 7.5

175060

From glove size 8.0

175061

DENTANOMIC Set – Gold Mixed

Complete Set, consisting of 3 standard handles (green, blue and pink – up to glove size 7.5) and 2 long handles (purple and orange – from glove size 8.0) + elevator blade set (all sizes) + luxator blade set (all sizes) + sterilisation and storage rack + honing set + sterilisation container

175072



175070

EICKWARM H₂O HEATING SYSTEM FOR SMALL ANIMALS

Prevent Intraoperative Hypothermia with the EickWarm H₂O Patient Heating System

Intraoperative hypothermia is one of the most common anaesthesia complications in small animal medicine. Effective perioperative heat management is crucial for reducing this risk and ensuring patient safety.

The EickWarm H₂O Patient Heating System provides safe and effective heat therapy with precise temperature control for small animals. By circulating demineralized water through a leak-proof heating mat, the system delivers conductive temperature therapy to prevent heat loss and hypothermia during surgery and recovery. The compact device operates quietly, ensuring a calm environment for both patients and staff. The efficient heating element quickly brings the warming mat to the desired temperature, providing immediate warmth. Additionally, by adding pre-cooled water, the device can be used to cool patients, offering versatile temperature management.

- ▶ Safe and effective control of the patient's body temperature
- ▶ Continuous temperature adjustment from 10 °C to 45 °C
- ▶ For use with demineralised water
- ▶ Digital temperature and water level display
- ▶ Three different timer modes
- ▶ Locking valves prevent the device from leaking when changing mats
- ▶ Includes two warming mats (L 55 x W 55 and L 55 x W 100 cm)
- ▶ Compact dimensions (in cm): L 19 x W 19 x H 17
- ▶ Weight: 1.2 kg

648020

Small Replacement Mat for EickWarm H₂O

- ▶ Dimensions (in cm) L 55 x W 55

E64802001

Large Replacement Mat for EickWarm H₂O

- ▶ Dimensions (in cm) L 55 x W 100

E64802002



648020



E64802001



E64802002

REUSABLE WARMING MATS

ORDER
ONLINE

www.eickemeyer.com

These reusable Warming Mats are placed under the patient and – thanks to their unique 3D textile structure – ensure optimal heat supply. The mats fit the body's contour perfectly, making temperature control possible in any position and without interruption at the contact points.

- ▶ Warm air is distributed evenly under the patient
- ▶ Pressure relieving positioning
- ▶ Free operating field
- ▶ Reusable and washable at 60 °C
- ▶ Compatible with most air warming devices
- ▶ Made in Germany

Small, 55 x 65 cm

648110

Large, 115 x 65 cm

648120

MOECK heating blanket for large heating mat incl. connecting hose

- ▶ Especially suitable for dental interventions
- ▶ In combination with the large heating mat, ensures optimal convective heat supply from above and below
- ▶ Variable round neck suitable for different head and body sizes

648130



648110

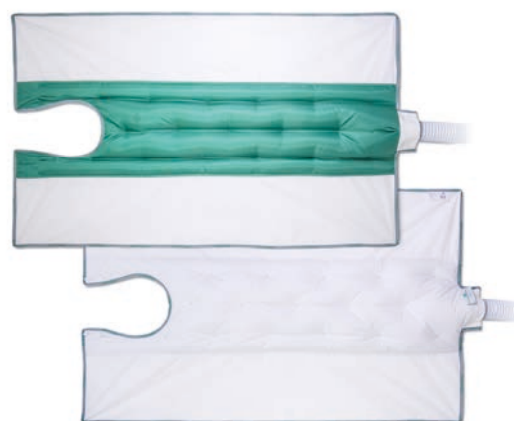

648130

EICKWARM AIR WARMING SYSTEM FOR SMALL ANIMALS

Intraoperative hypothermia is one of the most common anaesthesia complications in small animal medicine. Effective perioperative heat management is crucial for reducing this risk and ensuring patient safety. The new EickWarm Air Warming System quietly delivers forced air through optionally available warming mats that are specifically designed to evenly deliver diffused warm air to the patient.

- ▶ Safe and effective management of patient body temperature
- ▶ Optimal performance through uniform heat distribution
- ▶ Extremely powerful and quiet (≤55 dB)
- ▶ Only 60 seconds to warm up
- ▶ Temperature set points: Ambient air, 32 °C, 35 °C, 38 °C and 43 °C
- ▶ Three selectable fan levels (air flow)
- ▶ Reliable measurement of the hose outlet temperature using sensors
- ▶ Multiple alarm options ensure maximum patient safety
- ▶ Pole clamp for secure fixation
- ▶ Long heat hose (2 m) with flexible fastening clamp
- ▶ Compact dimensions (in cm): L 30 x W 37 x H 34
- ▶ Weight (including heat hose): 6.5 kg
- ▶ Warming mats available separately

648000



KOWA SL-19 PORTABLE SLIT LAMP

Now more ergonomic and even lighter!

With its rounded shape and curved handle design, the new KOWA SL-19 Slit Lamp is even more ergonomic. Furthermore, the weight of the hand-held unit has been significantly reduced.

- ▶ New LED backlight that can be used simultaneously with the slit light
- ▶ New LED blue light illumination for fluorescence observation
- ▶ Light intensity can be adjusted with one hand
- ▶ Infinitely adjustable slit length (1.5 – 12 mm)
- ▶ Longer operating time: up to 6 hours at maximum intensity
- ▶ Available in 5 colors: white, black, blue, green and pink

Technical specifications

- ▶ Magnification: 10x and 16x
- ▶ Working distance: about 80 mm at 16x magnification, about 100 mm at 10x magnification
- ▶ Effective field of view: Ø 10 mm at 16x magnification, Ø 15 mm at 10x magnification
- ▶ Slit width: Ø 0.1, Ø 0.2, Ø 0.8 mm
- ▶ Spot size: Ø 1, Ø 5, Ø 12 mm (slit length continuously adjustable from 1.5 – 12 mm)
- ▶ Light intensity: 200 – 20,000 lux (continuously adjustable)
- ▶ Power supply: 3x AA batteries (DC 4.8 – 6.4 V)
- ▶ Dimensions (in mm): W 197 x D 107 x H 238
- ▶ Weight (without batteries): only 620 g



173690

Illustration	Colour	Item No.
	White	173690
	Black	173691
	Blue	173692
	Green	173693
	Pink	173694



173691



173692



173693



173694

Carrying Case for SL-19

173695

KOWA SL-19 PLUS PORTABLE SLIT LAMP WITH CAMERA

ORDER
ONLINE

www.eickemeyer.com

The latest development from KOWA, the hand-held slit lamp SL-19 plus, impresses with its well-known ergonomic shape and light weight with an integrated, high-resolution camera. With a simple hand movement, videos can be recorded during the examination, which are automatically transmitted to an iPad (not included) via WiFi. Using special application software, these videos can be analysed and further processed on the iPad. High-resolution still images can also be extracted from the videos, which can be individually selected, saved and forwarded.

Carrying Case for SL-19 plus

173697

Technical specifications

- ▶ Magnification: 10x
- ▶ Working distance: approx. 100 mm
- ▶ Effective field of view: Ø 15 mm at 10x magnification
- ▶ Camera field of view: approx. 27 to 15 mm
- ▶ Effective pixel count: approx. 2 megapixels
- ▶ A camera indicator shows the operating status of the camera
- ▶ Operating time: approx. 8.5 hours if the device is switched off and disconnected from the iPad after each use, approx. 3.5 hours at full power without disconnecting from the iPad
- ▶ Dimensions (in mm): D 197 x W 107 x H 255
- ▶ Weight (without batteries): 730 g

173696



173696

OPTOMED AURORA® IQ FUNDUS CAMERA

The portable, patented AURORA® IQ fundus camera is a high-end retinal imaging device for the most demanding of needs. The user-friendly technology and large screen for instant display of high-quality retinal images, even with non-dilated pupils, make this device a must-have for every ophthalmologist. The included ocular surface lens has adjustable illumination levels, color imaging and cobalt blue for fluorescence imaging. Choose between autofocus or manual operation as desired.

- ▶ Complete set including anterior module
- ▶ Non-mydratic application possible in a darkened room
- ▶ Fast image capture with autofocus or manual operation
- ▶ Real-time visibility of the retina
- ▶ Large screen
- ▶ Detailed examination with 50° field of view
- ▶ Ocular surface lens for color imaging and cobalt blue for fluorescence imaging
- ▶ Adjustable illumination levels
- ▶ Transfer to the digital patient file via WLAN and USB
- ▶ Low-noise application
- ▶ 2-year guarantee (excluding batteries)
- ▶ Scope of delivery: AURORA® IQ fundus camera, retinal module, anterior module, 2 batteries, power supply, cleaning cloth, 2 eyecups, charging station, USB cable, client software for image transfer, carrying case

Technical specifications

- ▶ Field of view: 50° (total field of view: 50 x 40)
- ▶ Display TFT-LCD: 4", 800 x 480 pixels
- ▶ Operating time: approx. 2 hours with continuous use
- ▶ Camera dimensions (in mm): W 122 x H 202 x L 98
- ▶ Retinal module dimensions (in mm): W 68 x H 74 x L 160
- ▶ Anterior module dimensions (in mm): W 71 x H 80 x L 79
- ▶ Camera weight: 526 g

173700



NEW

ICARE TONOVET PLUS TONOMETER

The iCare TONOVET Plus is easy to use. It features an advanced user interface with a clear, large display. Red/green positioning lights help to find the correct angle and aim at the middle of the cornea. The automatic measuring sequence lets you choose between taking single readings or taking all 6 measurements with one press of the button.

- ▶ Quick, painless and accurate procedure
- ▶ Easy to use and requires no calibration
- ▶ Assisting positioning lights
- ▶ Large and easy to read colour display
- ▶ Dimensions (in mm): L 215 x W 24–29 x D 35–95
- ▶ Weight: 230 g (incl. batteries)
- ▶ Includes: Transport Case, 100 Probes, 4x AA batteries

1736007

 QR code for the application video of the TONOVET Plus

Stand for TONOVET and TONOVET Plus

- ▶ Table and wall mountable

1736008

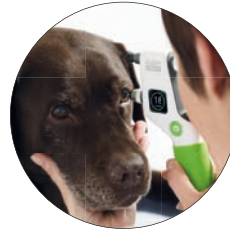

Application



ICARE TONOVET PRO TONOMETER

The iCare TONOVET Pro tonometer sets new standards in intraocular pressure (IOP) measurement and is aimed at vets who have the highest demands on accuracy and ease of use. The innovative "Quick Measure" function enables faster and easier measurement of the IOP and significantly shortens the examination time, while the more responsive test tip and the optimised test tip control ensure improved handling and even more precise measurements. The 200-degree positioning freedom makes the TONOVET Pro tonometer an indispensable helper even in emergency situations. The ergonomic display is designed to allow the user to instantly read the measured values.

- ▶ Improved user-friendliness
- ▶ 200-degree positioning freedom (ideal for equine use)
- ▶ More responsive test tip
- ▶ Better test tip control improves accuracy
- ▶ Display facing the user
- ▶ Self-calibrating
- ▶ Wireless printing via Bluetooth
- ▶ Includes: Transport Case, 100 TONOVET Probes, 4x AA batteries

173627

Probes for TONOVET

- ▶ 100 per pack

1736006



Application



173627

HEINE OMEGA 600 INDIRECT OPHTHALMOSCOPE

**ORDER
ONLINE**

www.eickemeyer.com

Discover more. With less weight.

Lighter. Brighter. Better. HEINE kept the best and perfected the rest. Highly comfortable, the HEINE OMEGA 600 delivers a new class of technological innovation, along with the new and unique visionBOOST for significantly better diagnostic even in dense cataracts.

- ▶ Most precise diagnostic, up to the far retinal periphery
- ▶ Up to 20 % better view in media opacities with visionBOOST
- ▶ Lightest High-End Indirect Ophthalmoscope worldwide
- ▶ Long-lasting investment due to its robust design
- ▶ Easy disinfection thanks to smoothSURFACE

Most precise diagnostic, up to the far retinal periphery

- ▶ Significantly better diagnostic due to unique visionBOOST
- ▶ Sharpest fundus image due to superior glass optics
- ▶ Brightest fundus image with true colour rendering thanks to our unique LEDHQ – now in even more natural colours
- ▶ Best 3D imaging due to our unique Stereoscopic Adjustment
- ▶ Technology in dilated and undilated pupils

Includes

OMEGA 600 Indirect Ophthalmoscope (with battery and +2 D eyepiece), E4-USBC power supply with cable, eyepiece 0 D

173497

CB1 Charging Battery

17349702



173497

HEINE DIAGNOSTIC SET

Absolute precision is the basic requirement to ensure the creation of a high-quality product. At HEINE this principle applies to the entire production process.

Complete set, consisting of:

NT 300 Double Charger (302550)

- ▶ Automatic charging process and overcharge protection
- ▶ Includes two NT 3.5 V Battery Handles including batteries (2x 302535)
- ▶ With short-circuit protection and a continuous ceramic brightness control

BETA 200 LED Ophthalmoscope (300137)

The HEINE BETA 200 LED Ophthalmoscope offers a bright, clear view with durable LEDHQ technology and precise dimming, ideal for reliable mobile diagnostics.

G100 LED Slit Illumination Head (300036)

The HEINE G100 VET LED features 1.6x magnification and precise, dimmable LED HQ lighting in a robust all-metal housing, ensuring optimal visibility and reliable diagnostics.

Replacement lamp can be ordered through item no. 300038.

Otoscope Specula

- ▶ High quality chrome plated metal construction, which is easy to clean, disinfect and sterilise
- ▶ Metal Speculum, 4x 57 mm (300357)
- ▶ Metal Speculum, 6x 65 mm (300365)
- ▶ Metal Speculum, 7x 90 mm (300390)

EXP302550



EICKEMEYER® POCKET DIAGNOSTIC SET

The EICKEMEYER® POCKET veterinary otoscope and ophthalmoscope are perfect for home visits due to their small size.

EICKEMEYER® POCKET Veterinary Otoscope

- ▶ Dimmable LED ring with 6 LEDs (concentric)
- ▶ Illumination intensity: approx. 10,000 lux
- ▶ Color temperature: 4,200 K
- ▶ Lifespan of LEDs: approx. 100,000 hours
- ▶ Swiveling 1.7x magnifying glass
- ▶ Maintenance-free, no lamp replacement necessary
- ▶ Automatic switch-off after 3 minutes
- ▶ Power supply: 2x AAA alkaline batteries, included
- ▶ Incl. three veterinary specula (57 x 4 mm, 65 x 6 mm and 90 x 7 mm)

300100



300100

EICKEMEYER® POCKET Veterinary Ophthalmoscope

- ▶ 5 apertures: crosshair, large circle, small circle, semicircle, green filter
- ▶ Correction range: + 20 to - 20 D
- ▶ Dimmable LED lighting
- ▶ Illumination intensity: approx. 10,000 lux
- ▶ Color temperature: 4,200 K
- ▶ Lifespan of LEDs: approx. 50,000 hours
- ▶ Maintenance-free, no lamp replacement necessary
- ▶ Automatic switch-off after 3 minutes
- ▶ Power supply: 2x AAA alkaline batteries, included

300110



300110

EICKEMEYER® POCKET Diagnostic Set

- ▶ Includes: EICKEMEYER® POCKET Veterinary Otoscope and EICKEMEYER® POCKET Veterinary Ophthalmoscope

300120



FREEZPEN 16G

ORDER
ONLINE

www.eickemeyer.com

Freezpen – Cryosurgery made simple

Freezpen combines leading-edge microtechnology and ergonomic design to make precision cryosurgery easier, more precise and more accessible than ever.

- ▶ Simple, stress-free removal of skin lesions and small tumours without anaesthesia
- ▶ Simply treat lesions and tumours on the body, legs, mouth, nose, ears or in the eye area

Simple procedure – outstanding results

With Freezpen, removing skin lesions and small tumours is simple, fast and highly effective - and there's no need for anaesthesia. The ultra-fine jet of N₂O targets only the lesion or tumour itself, leaving healthy tissue untouched. Minimal or no post-treatment care needed.

Simply powerful

Freezpen's high-pressure jet of N₂O achieves extremely low temperatures (-27°C) at 3mm depth in just 15 seconds.

Simply precise

The ultra-fine jet and choice of applicators gives total control. Opt for a micro-applicator for pinpoint accuracy, a larger one for broader coverage, or a longer one (optional) for hard-to-reach areas.

Simply practical

With no special storage requirements, your Freezpen can always be within easy reach. Cartridges are stored at room temperature and can be changed in seconds.

Technical data

- ▶ Treatment temperature: -89 °C / -128 °F
- ▶ Pressure: 50–55 bar
- ▶ Incl. 3 autoclavable applicators:
 - Blue: Ø 1–3 mm (230–270 seconds flow time)
 - White: Ø 2–6 mm (145–180 seconds flow time)
 - Green: Ø 4–8 mm (110–130 seconds flow time)
- ▶ Incl. 6x 16 g N₂O cartridges

173400

N₂O cartridges

- ▶ Pack of 12

173405



173400



173405



QR code to
the video of
the Freezpen

EICKVIEW SD ENDOSCOPY SYSTEM

Unlock the future of veterinary care with the EickView SD Endoscopy System!

This state-of-the-art system features a high-quality endoscopy monitor with a large, intuitive touchscreen, seamlessly connecting to three versatile “semi-disposable” endoscopes. This system allows the veterinary practitioner to experience the benefits of flexible endoscopy (Gastroscopy, Bronchoscopy, Rhinoscopy, etc.) without the hefty investment of traditional video endoscopes. Each endoscope is equipped with a high-resolution CMOS image sensor and an LED light source, ensuring crystal-clear visuals.

EickView SD Endoscopy Monitor

- ▶ 15.6" touchscreen with 1,920 x 1,080 Full HD resolution
- ▶ Functions: White Balance, Zoom, Freeze, photo (JPG) and video recording (MP4)
- ▶ 64 GB storage capacity
- ▶ Mains and battery operation, battery life up to 5 hours
- ▶ Outputs: HDMI, DVI, SDI and USB
- ▶ Dimensions (in cm): W 39 x H 25 x D 4
- ▶ Weight: 2.7 kg

307000

EickView 150SD

- ▶ Working length: 150 cm
- ▶ Ø outside: 6.0 mm
- ▶ Ø working channel: 2.9 mm
- ▶ Direction of view: 0°
- ▶ Viewing angle: 120°
- ▶ Bending up / down: 180°
- ▶ Bending right / left: 120°

307010

EickView 60SD

- ▶ Working length: 60 cm
- ▶ Ø outside: 3.2 mm
- ▶ Ø working channel: 1.2 mm
- ▶ Direction of view: 0°
- ▶ Viewing angle: 120°
- ▶ Bending up / down: 210°

307020

EickView 60SD-XS

- ▶ Working length: 60 cm
- ▶ Ø outside: 2.7 mm
- ▶ Ø working channel: 1.2 mm
- ▶ Direction of view: 0°
- ▶ Viewing angle: 120°
- ▶ Bending up / down: 210°

307030



EICKVIEW 5-IN-1 ENDOSCOPY SYSTEM

**ORDER
ONLINE**
www.eickemeyer.com

EickView 5-in-1 Endoscopy System

The EickView 5-in-1 endoscopy system is a true all-rounder for veterinary medicine. The easy-to-use, mobile device offers the option to work with both, flexible and rigid endoscopes. This means that all types of endoscopy can be covered with just one device – from diagnosis to surgical procedures.

The EickView 5-in-1 combines a large, 15.6" Full HD display, a powerful LED light source, a connection for flexible endoscopes from the EickView HD series with air and water pump as well as digital data storage via SD Card in one system.

306200

EickView HD and HD+ Video Endoscopes

The EickView HD and HD+ Video Endoscopes deliver brilliant images for bronchoscopy, gastroscopy and various other applications. The new HD+ Endoscopes are characterised by their reduced outer diameters and enlarged working channels, making them even more variable. Due to the large number of available scope sizes, they are suitable for all applications in small animals and equine.

Technical specifications

- ▶ Viewing direction: 0°
- ▶ Distal end contains 1 CMOS Camera Chip, 2 Light Guides, Working Channel, Lens Rinsing Nozzle
- ▶ Scope of delivery: EickView Video Endoscope, Pressure Tester, 2 Cleaning Brushes, Cleaning Set, Carrying Case



306201



EickView HD Video Endoscopes							
Art. Nr.	Description	Working length	Outer Ø	Working channel	Depth of field	Field of view	Deflection
306177	EickView 60 HD Endoscope	60 cm	3.5 mm	1.2 mm	3 – 50 mm	120°	Angle above: 160° Angle below: 130° Angle right / left: 0°
306178	EickView 100 HD Endoscope	100 cm	6.0 mm	2.0 mm	3 – 50 mm	120°	Angle above: 210° Angle below: 90° Angle right / left: 100°
306266	EickView 150-6 HD+ Endoscope	150 cm	6.0 mm	2.8 mm	2 – 100 mm	120°	Angle above: 210° Angle below: 90° Angle right / left: 100°
306268	EickView 150-8 HD+ Endoscope	150 cm	8.0 mm	2.8 mm	3 – 50 mm	120°	Angle above: 210° Angle below: 90° Angle right / left: 100°
306270	EickView 350 HD+ Endoscope	350 cm	13.0 mm	3.7 mm	3 – 100 mm	140°	Angle above: 180° Angle below: 180° Angle right / left: 160°

EICKEMEYER® DOPPLER

Reliable and accurate non-invasive blood pressure monitor for small animals.

- ▶ Compact, hand-held design
- ▶ High sensibility for a clear signal
- ▶ Adjustable sound volume and headphone connection
- ▶ Focused 8 MHz Probe with wide beam for better flow detection in the artery
- ▶ Probe adapted for positioning on the animals tail or paw
- ▶ Rechargeable battery powered, operating time: ±6 hours
- ▶ Dimensions (in mm): L 175 x W 80 x H 25 mm
- ▶ Lightweight (300 g)

217210

Sphygmomanometer

- ▶ One-hand operation
- ▶ Includes two cuffs: 5.0 and 7.5 cm

217309

Doppler Blood Pressure Cuff, 1.9 cm

- ▶ Ideal for small cats

217307

Doppler Blood Pressure Cuff, 3.3 cm

- ▶ Ideal for cats & small dogs

217308

Doppler Blood Pressure Cuff, 10 cm

- ▶ Ideal for large dogs

217311



217210



217309



217308

